

WxS 880-008/13

LoRaWAN Acceleration sensor

Product Highlights



- ✓ The two-axis part is a high-precision acceleration data. 0.244 mg resolution; ± 1.7 g accelerometer measurement range
- ✓ Triaxial part, It has dynamically user selectable fullscales of $\pm 2g/\pm 4g/\pm 8g/\pm 16g$ and it is capable of measuring accelerations.
- ✓ Cross-threshold report, plus periodic report every 2 hours (the threshold and the periodic report cycle are both user-configurable)
- ✓ OTA (Over The Air) firmware upgrade, including to upgrade loader and application images
- ✓ Analog and digital interface for external sensor connectivity and pulse counting (MPI)
- ✓ Low power consumption, 5 – 10 years of battery operational life with 2 x AA Li-SOCI2 Battery
- ✓ Optional DC 5V power source
- ✓ Integrated internal antenna, or optional external SMA/IPEX antenna
- ✓ Up to 5km reach in NLoS (Non-Line-of-Sight) and up to 18km LoS (Line-of-Sight) environments
- ✓ IP67 enclosure rating

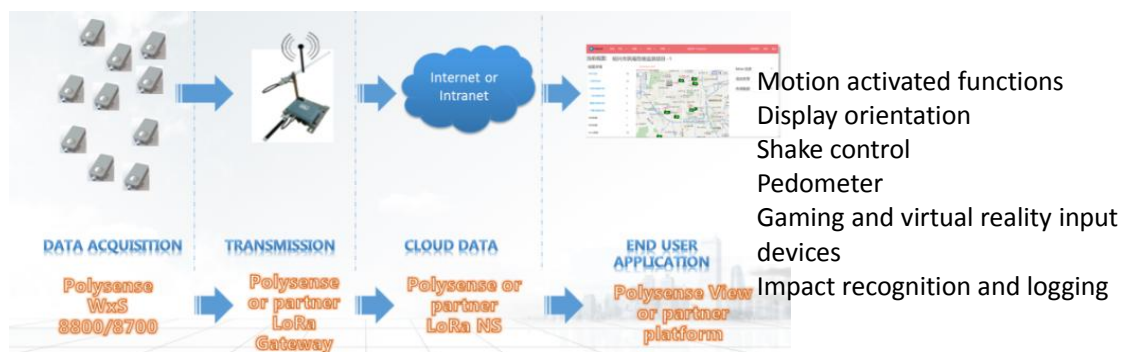

Application Architecture



Specifications



Parameter	Value
Sensor	
2-axis acc resolution	0.244 mg resolution
2-axis acc measurement range	± 1.7 g
3-axis acc resolution	4mg/8mg/16mg/48mg optional
3-axis acc measurement range	$\pm 2g/\pm 4g/\pm 8g/\pm 16g$ optional
Frequency domain response	3~280HZ
Data Report	Cross-threshold report, plus periodic report every 2 hours (the threshold and the periodic report cycle are both user-configurable)
Wireless	
ISM Band	EU 863 – 870MHz; US 902 – 928MHz China 779 – 787MHz; EU 433MHz AS 923MHz; CN 470 – 510MHz
Maximum Link Budget	168dB
Distance	Up to 5km NLOS; up to 18km LOS
Antenna	Integrated internal antenna or external 1/2 wavelength whip antenna (SMA)
Mechanical	
Dimension	60mm x 100mm x 30mm (WxS8800)
IP rating	IP67 (WxS8800)
Operating Temperature	-40C to +85C (WxS8800); -40C to +125C (sensor)
Cable length	0.5 meters
Total Weight	120 g
Electrical	
Supply Voltage	3.0 – 3.8 VDC
Power Type	Replaceable 1 or 2 AA 3.6V Li-SOCI2 Battery; DC 4.5V – 12V optional
Battery Life	5 – 10 years (assume one motion event one day)
Compliance/Certification	
 LoRa Alliance	LoRaWAN 1.0.2
 FC  Industry Canada	FCC ID: 2A07W-WXS8000, IC: 23701-WXS8000

Installation Guide

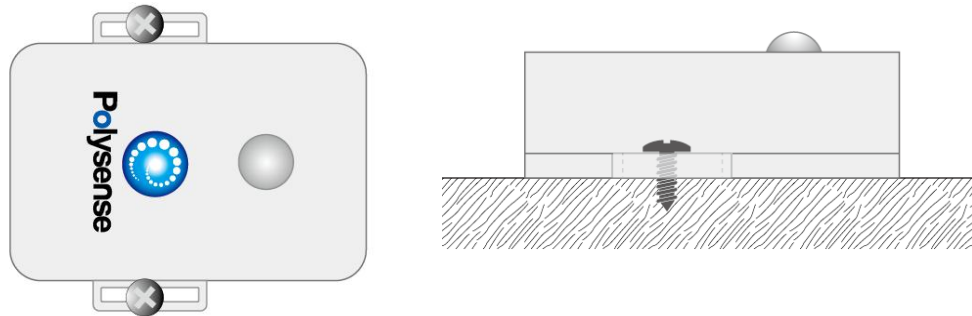
Below diagram shows the general installation guide for WxS8800, it can be installed on any flat and solid surface, the lid is contacted with the surface and fixed via 2 self-tapping screws:

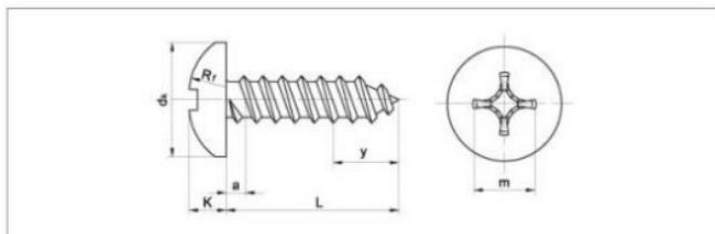

Below is the recommendation of the self-tapping screw and its sizes:



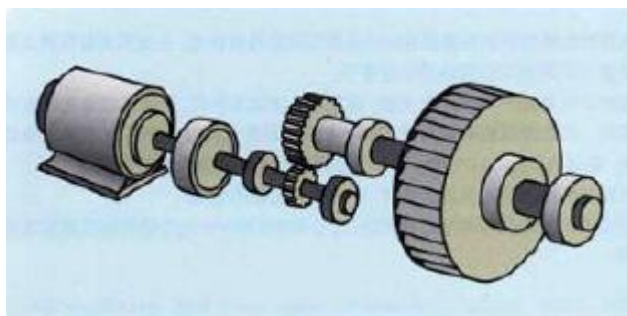

螺纹规格		ST2.2	ST2.9	ST3.5	ST4.2	ST4.8	ST5.5	ST6.3
dk	min	3.7	5.3	6.64	7.64	9.14	10.57	11.57
K	min	1.4	2.15	2.35	2.8	3.4	3.7	4.3
m		1.9	3	3.9	4.4	4.9	6.4	6.9
L		4.5mm-100mm						

Product Sample Applications

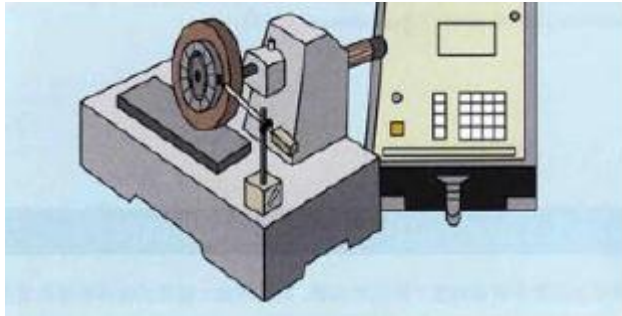

Monitoring of abnormal vibrations in factories, machine diagnosis



Measurement of unbalanced vibration



Research into the vibration characteristics of manufactured products, reliability testing, and pre-shipment inspections



Studies of the earthquake resistance of large structures



Monitoring of the operation of air conditioners



Surveys of vibration pollution

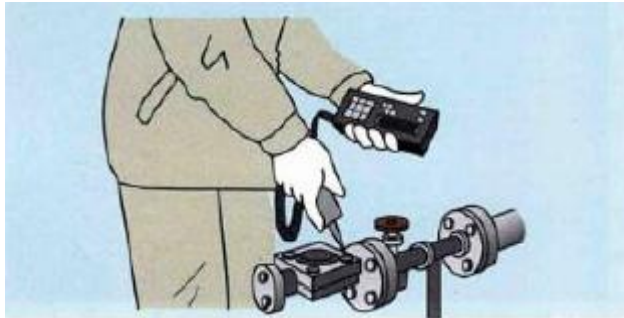

leak detection of pipe and trap



Measurement of vibration and shocks during product transportation



Studies of the ride quality of vehicles



Development of sporting equipment



Sensor principle

The WxS8800 has two built-in sensors that meet the measurement needs of low power consumption.

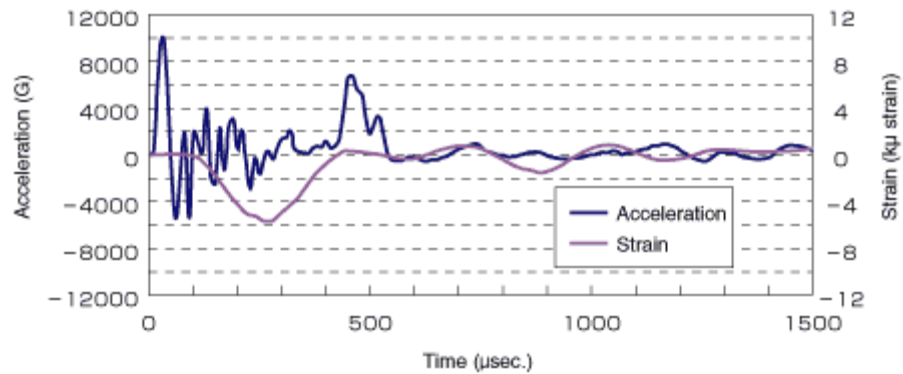

In addition to being able to report measurement data periodically, it is also possible to determine the change in state after edge calculation.

Such as: object prohibition or movement, change in the direction of motion, change in exercise intensity, and so on.

We also provide an edge application algorithm for FFT

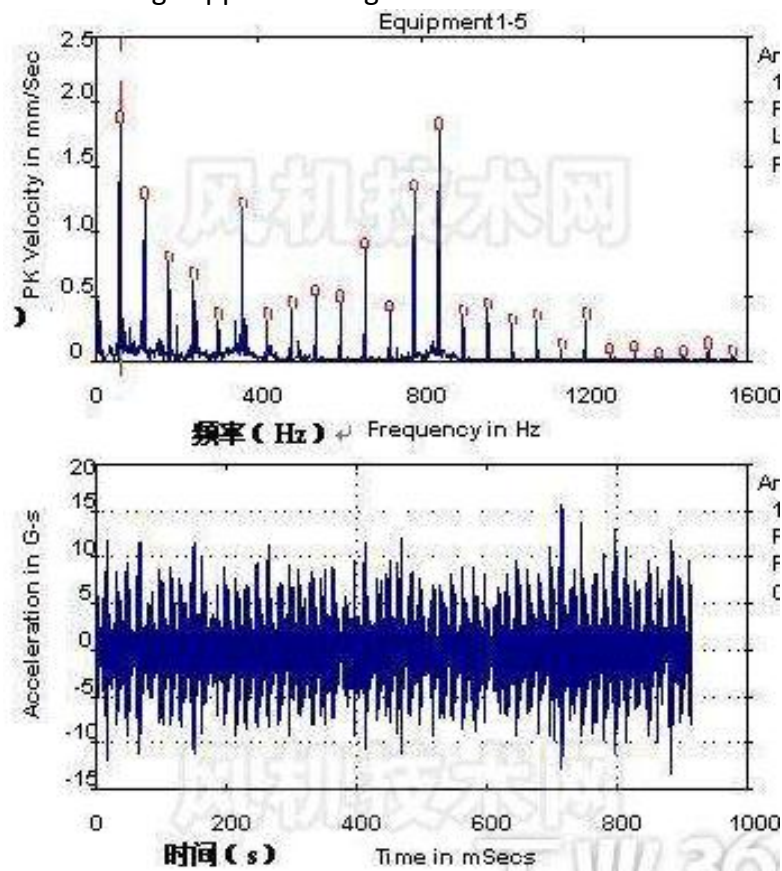



In addition, we support to report the vibration frequency, velocity and amplitude directly. These algorithms will provide strong support for real-time monitoring of rotating devices

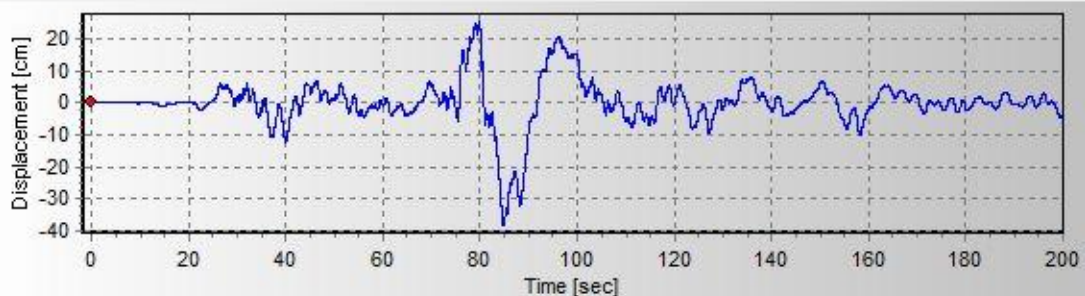
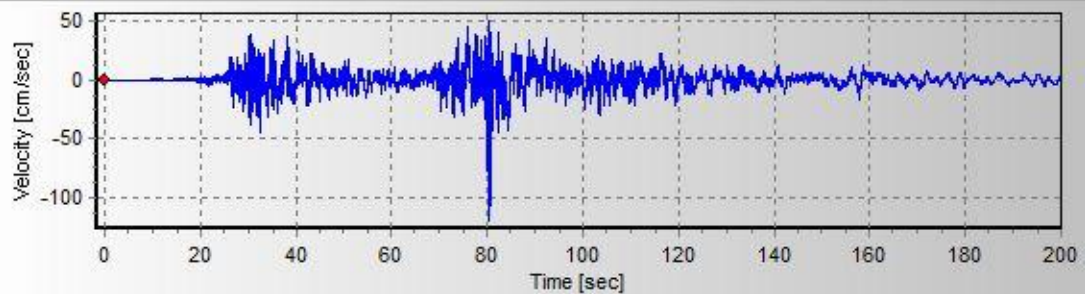
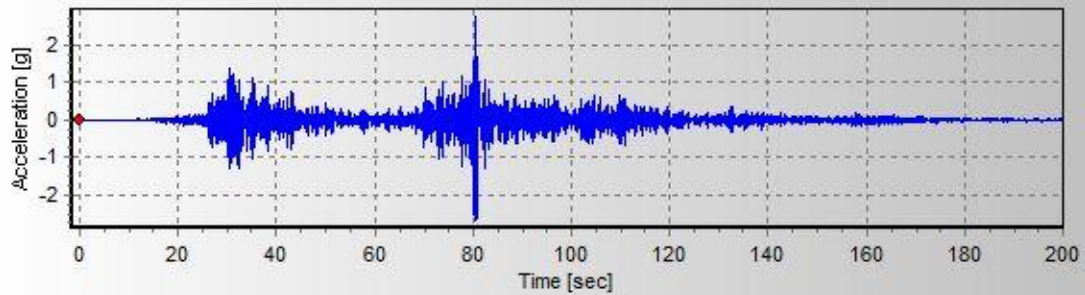



Polysense Technologies

About Polysense

Polysense develops products and solutions for Industrial IoT and smart homes, including distributed fiber sensing, LPWAN LoRa and NB-IoT based wireless IoT sensors, Passive Optical Network (PONs) and cloud based data management and analytic platform.

Contact Polysense

Silicon Valley Office
3000 Scott Blvd, Suite 108
Santa Clara, CA 95054



Beijing Office
26 Information Road, Suite 820
Haidian District, Beijing, China



Shanghai Office
88 Shengrong Road, Bldg #1, Suite 416
Pudong District, Shanghai, China

